

Part # BS-CASS XX + XX

061215

PARTS



A

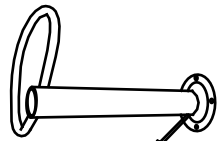

B

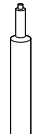

C

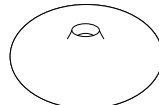

D

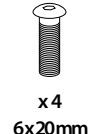

x4
6x20mm

E

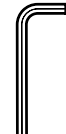

F

1

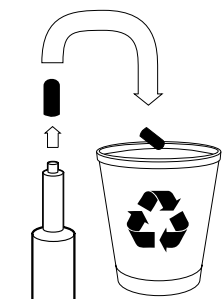

REMOVE
BLACK CAP
AND THROW
AWAY

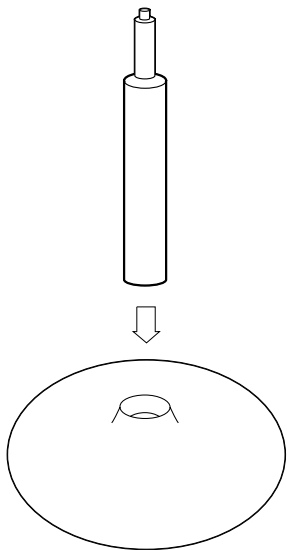

C

D

2

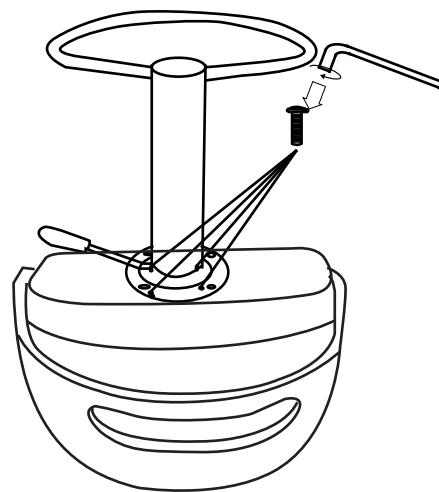

F

E

B

A

3

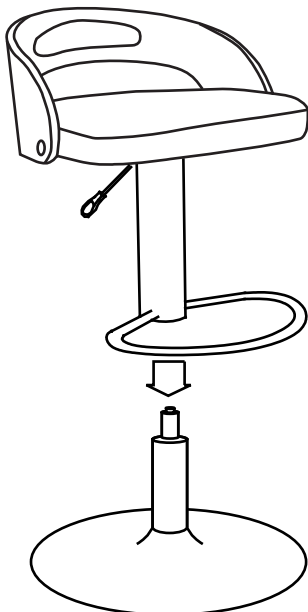

4

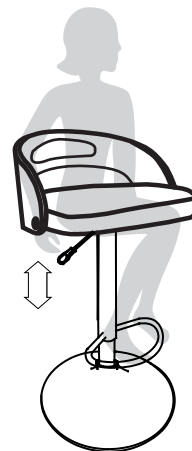

SIT TO SECURE

